

FRONT & SIDE VIEW

MODEL DL1802A
 1800lb/817kg CAPACITY
 PULLING WINCH

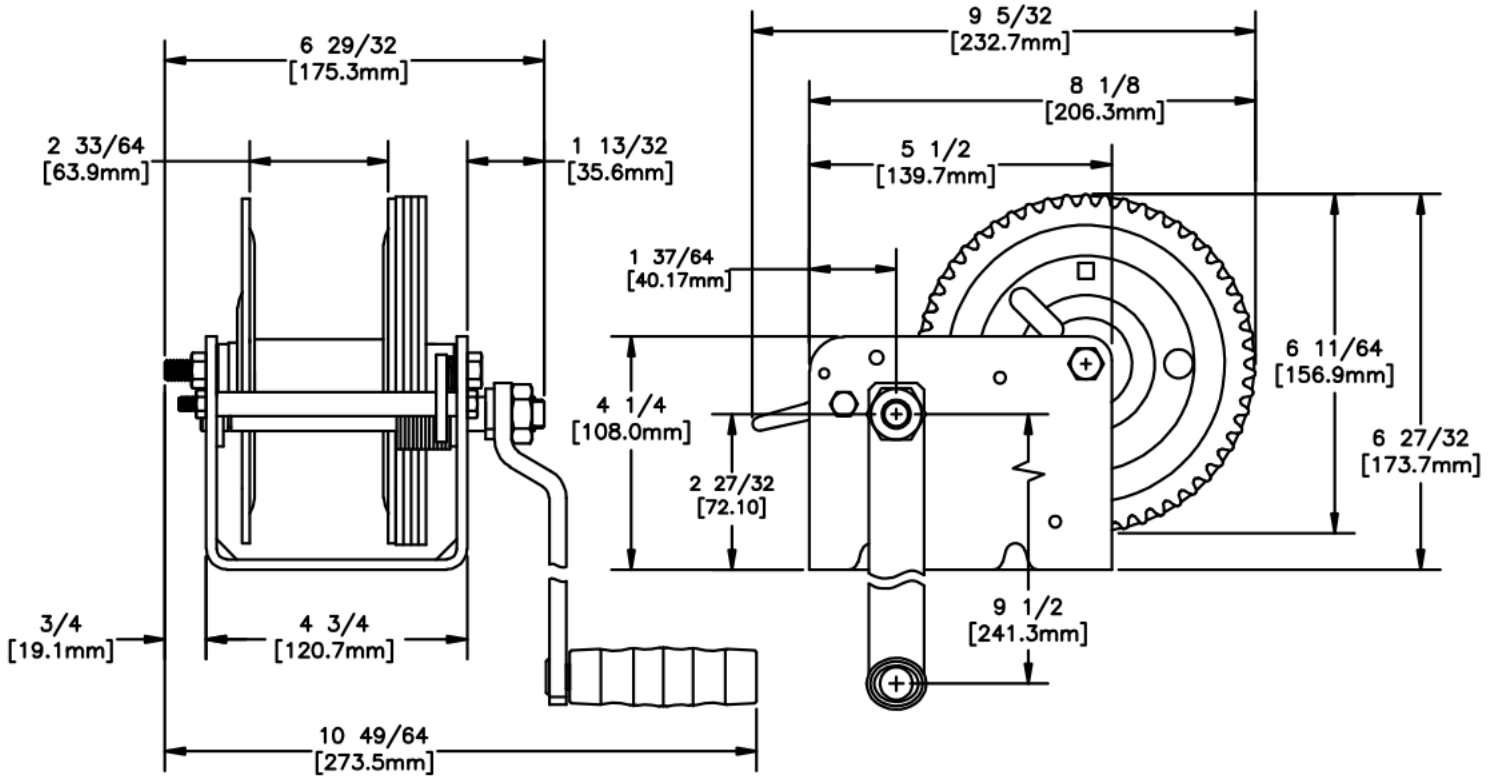

BASE HOLE PATTERN

